



09

AKSESUARLAR
ACCESSORIES

09

AKSESUARLAR
ACCESSORIES



190
Elektrostatik Sarı Boyalı
Electrostatic Yellow Painted



190 K
Krom Kaplamalı
Chrome Plated

190 SN
Saten Nikel Kaplamalı
Satin Nickel Plated

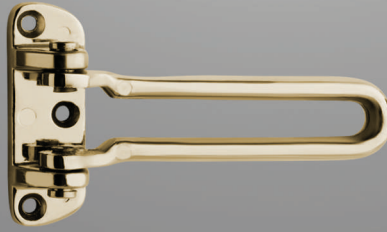
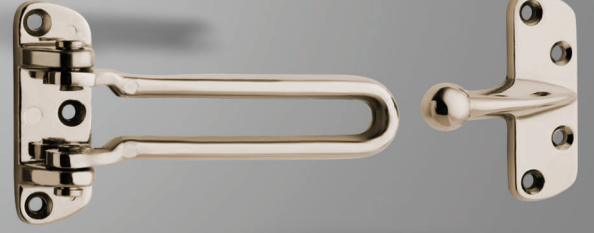

190 P
Pirinç Kaplamalı
Brass Plated



190 AB
Antik, Pirinç Kaplamalı
Antique Brass Plated

190 / 190 K / 190 SN / 190 P / 190 AB

EMNİYET KELEPÇESİ
AHŞAP, METAL VE ÇELİK KAPILAR İÇİN
DOOR RETAINER
FOR WOODEN, METAL DOORS AND STEEL DOORS

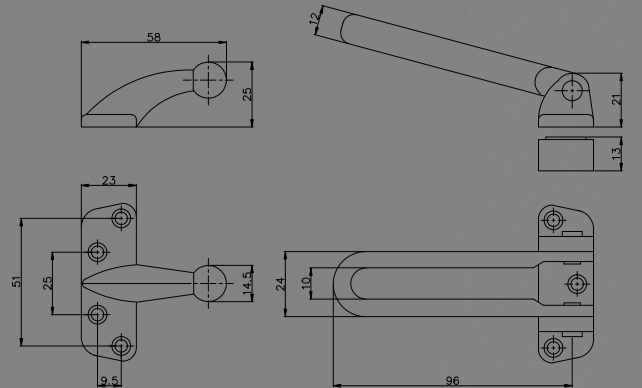

Teknik Bilgiler:

- > Gövde: Özel alaşımli zamak döküm.
- > Karşılık: Özel alaşımli zamak döküm.

Technical Information:

- > Case: Cast zinc alloy.
- > Striking: Cast zinc alloy.

Kod
Code : 190 / 190 K / 190SN/190 P / 190 AB

Birim Ağırlığı
Unit Weight : 263 gr.

Koli İçi Adeti
Pieces per Carton Box : 20

Koli Ölçüsü
Carton Box Dimension : 39X21X16.3 cm.

Koli Ağırlığı
Carton Box Weight : 5260 gr.



500
Pirinç Kaplamalı
Brass Plated



500 SN
Saten Nikel Kaplama
Satin Nickel Plated



500 K
Krom Kaplamalı
Chrome Plated

500 / 500 K / 500 SN

ÇELİK KAPI KİLİTLERİ İÇİN KORUYUCU ROZET
SECURITY ESCUTCHEON FOR STEEL DOOR LOCKS

Teknik Bilgiler:

> Gövde : Delinmeye mukavim sertleştirilmiş çelik. Pirinç, krom veya saten nikel kaplı.

Technical Information:

> Case: Extra hardened steel. Brass, chrome or satin nickel plated.

Kod
Code : 500 / 500 K / 500 SN

Birim Ağırlığı
Unit Weight : 282 gr.

Koli İçi Adeti
Pieces Per Carton Box: 20

Koli Ölçüsü
Carton Box Dimension : 32X20X12.8 cm.

Koli Ağırlığı
Carton Box Weight : 5640 gr.



511
Pirinç Kaplamalı
Brass Plated



511 K
Krom Kaplamalı
Chrome Plated



511 SN
Saten Nikel Kaplı
Satin Nickel Plated

511 / 511 K / 511 SN

FİŞELİ ÇELİK KAPI KİLİTLERİ İÇİN KORUYUCU ROZET
SECURITY ESCUTCHEON FOR DOUBLE-BIT KEY STEEL DOOR LOCKS

Teknik Bilgiler:

> Gövde : Zamak döküm. Pirinç, krom veya saten nikel kaplı.

Technical Information:

> Case: Zinc alloy. Brass, chrome or satin nickel plated.

**502****SİLİNDİR ROZETİ
CYLINDER ROSETTE****Teknik Bilgiler:**

> Gövde : Pirinç, (Opsiyonel: Nikel kaplamalı)

Technical Information:

> Case: Brass. (Optional: Nickel plated.)

**503****SİLİNDİR ROZETİ
DAR KİLİTLER İÇİN
CYLINDER ROSETTE
FOR NARROW TYPE LOCKS****Teknik Bilgiler:**

> Gövde : Çelik, Pirinç kaplamalı.
(Opsiyonel: Nikel kaplamalı)

Technical Information:

> Case: Steel, Brass plated.
(Optional: Nickel plated.)

**507****DIŞTAN TAKMA EMNİYET VE TİRAJLI KİLİT ROZETİ
FOR SURFACE MOUNT SAFETY AND RIM LOCKS****Teknik Bilgiler:**

> Gövde : Çelik, Pirinç kaplamalı.
(Opsiyonel: Nikel kaplamalı)

Technical Information:

> Case: Steel, Brass plated.
(Optional: Nickel plated.)

**509****PRAZİS SİLİNDİR ROZETİ
FOR CROSS KEY TYPE LOCKS****Teknik Bilgiler:**

> Gövde : Pirinç, (Opsiyonel: Nikel kaplamalı)

Technical Information:

> Case: Brass. (Optional: Nickel plated.)



162

İÇ KAPI GÖMME KİLİT
HAM ANAHTARI
BLANK KEY FOR INTERIOR
MORTISE LOCKS

Teknik Bilgiler:

> Anahtar: Özel zamak döküm.
Pirinç kaplamalı. 6 farklı profil.
151, 158 K, 166 kilitleri için.

Technical Information:

> Key: Zinc alloy. Brass plated.
6 different profiles. For 151, 158
K, 166 locks

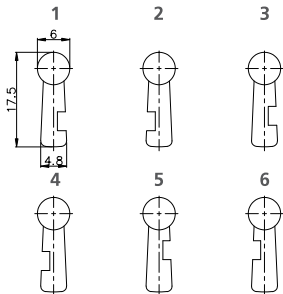
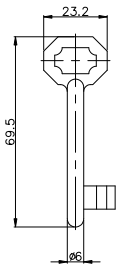

171

İÇ KAPI GÖMME KİLİT
HAM ANAHTARI
BLANK KEY FOR INTERIOR
MORTISE LOCKS

Teknik Bilgiler:

> Anahtar: Özel zamak döküm.
Pirinç kaplamalı. 8 farklı profil.
151 R, 151 RM, 151 RP, 141,
kilitleri için.

Technical Information:

> Key: Zinc alloy. Brass plated.
8 different profiles. For 151 R,
151 RM, 151 RP, 141 locks

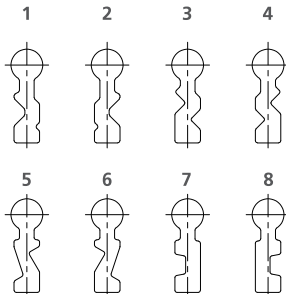
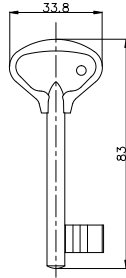

176

İÇ KAPI GÖMME KİLİT
HAM ANAHTARI
BLANK KEY FOR INTERIOR
MORTISE LOCKS

Teknik Bilgiler:

> Anahtar: Özel zamak döküm.
Pirinç kaplamalı. 8 farklı profil.
166 AR, 166 ARM, 266 P kilitleri
için.

Technical Information:

> Key: Zinc alloy. Brass plated.
8 different profiles. For 166 AR,
166 ARM, 266 P locks.

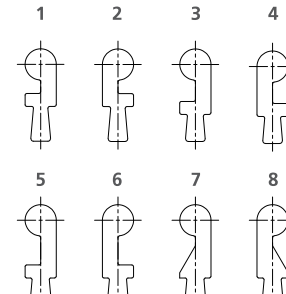
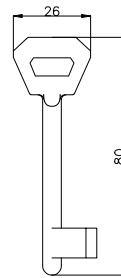

172 H

İÇ KAPI GÖMME KİLİT
HAM ANAHTARI
BLANK KEY FOR INTERIOR
MORTISE LOCKS

Teknik Bilgiler:

> Anahtar: Özel zamak döküm.
Pirinç kaplamalı. 6 farklı profil. 32
değişik şifre. 172 ve 172 E kilitleri
için.

Technical Information:

> Key: Zinc alloy. Brass plated. 6
different profiles. 32 various key
codes. For 172 and 172 E locks.

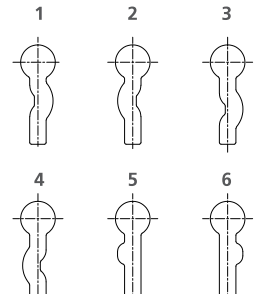
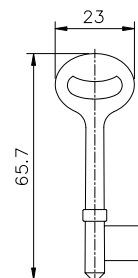



160/2-160/3

BİLYALI SİLİNDİR HAM ANAHTARI
BLANK KEY FOR HIGH SECURITY CYLINDER

Teknik Bilgiler:

> Anahtar: Pirinç. Nikel kaplamalı. Multikanallı. Bilyalı. (160/2 iki kanallı, 160/3 üç kanallı)

Technical Information:

> Key: Brass. Nickel plated. Multiwave. High security cylinder. (160/2 double wave, 160/3 triple wave)

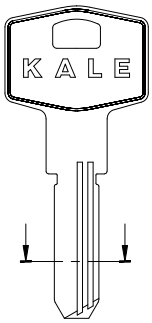

KOD 160-2

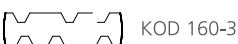

KOD 160-3

Kod Code : 160/2-160/3

Birim Ağırlığı Unit Weight : 14.2 gr.

161 F2/161 F3

PRAZİS SİLİNDİR HAM ANAHTARI
CROSS TYPE BLANK KEY

Teknik Bilgiler:

> Anahtar: Çelik. Yıldız profil kesitli. Nikel kaplamalı. (Opsiyonel: 161 F2 anahtar 101F oto emniyet kilidine uygundur.)

Technical Information:

> Key: Steel. Cross key type. Nickel plated. (Optional: 161 F2 keys are available for 101 F car security lock)

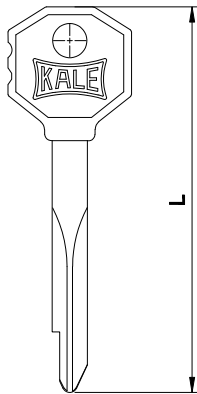

Tip Type	L
161 F2	64,5
161 F3	76,4

Kod Code : 161 F2 : 161 F3

Birim Ağırlığı Unit Weight : 15 gr. : 19 gr.

161 / 1-2-3

STANDART SİLİNDİR HAM ANAHTARI
BLANK KEY FOR STANDARD CYLINDER

Teknik Bilgiler:

> Anahtar: Pirinç. Nikel kaplamalı. (161/1 iki kanallı, 161/2 iki kanallı ters, 161/3 üç kanallı)

Technical Information:

> Key: Brass. Nickel plated. (161/1 double wave, 161/2 reverse double wave, 161/3 triple wave)

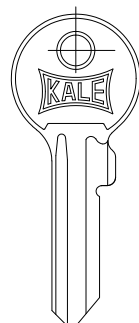

KOD 161-1

KOD 161-2

KOD 161-3

Kod Code : 160/1-161/2-161/3

Birim Ağırlığı Unit Weight : 10.8 gr.

168

SİSTEM SİLİNDİR HAM ANAHTARI
BLANK KEY FOR SYSTEM CYLINDER

Teknik Bilgiler:

> Anahtar: Pirinç. Nikel kaplamalı. Multikanallı.

Technical Information:

> Key: Brass. Nickel plated. Multiwave.

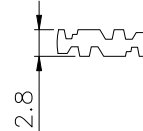
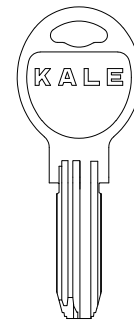

2.8

Kod Code : 168

Birim Ağırlığı Unit Weight : 21 gr.

505 K

FİŞELİ KİLİT HAM ANAHTARI
BLANK KEY FOR DOUBLE-BIT KEY LOCKS

Teknik Bilgiler:

> Anahtar: Özel pirinç döküm. Nikel kaplamalı. 252 RL ve 257 L kilitleri için.

Technical Information:

> Key: Brass alloy. Nickel plated. For 252 RL and 257 L locks.

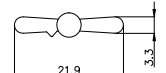
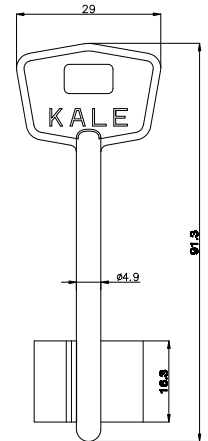

21.9

3.3

Kod Code : 505 K

Birim Ağırlığı Unit Weight : 15 gr.

305/305 S/ 305 WC

TAKIM KOL
DIŞ, İÇ VE WC KAPI KİLİTLERİ İÇİN
HANDLE SET
FOR EXTERIOR, INTERIOR DOOR AND WC DOOR LOCKS

Teknik Bilgiler:

> **Ayna:** Çelik. Elektrostatik boyalı. Vernikli.

> **Kollar:** Alüminyum enjeksiyon döküm. Elektrostatik boyalı. Vernikli.

Technical Information:

> **Forend Plate:** Steel. Electrostatic painted. Varnished.

> **Handles:** Aluminium alloy. Electrostatic painted. Varnished.



Kod
Code : 315 SB / SC / B / C
Birim Ağırlığı
Unit Weight : 590 gr.
Koli İçi Adeti
Pieces Per Carton Box : 30
Koli Ölçüsü
Carton Box Dimension : 47.5X28.5X22.5 cm.
Koli Ağırlığı
Carton Box Weight : 17700 gr.

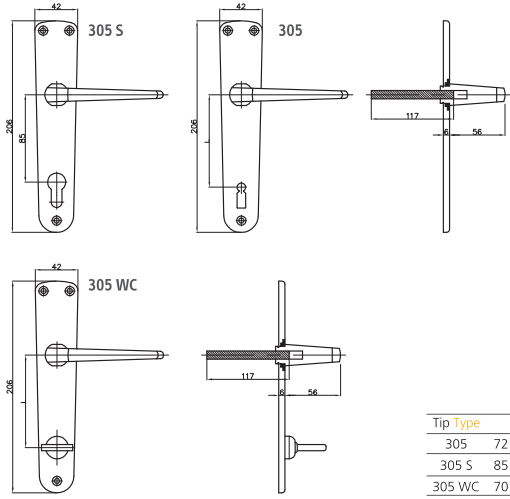

Tip Type	L
305	72 90
305 S	85
305 WC	70 72 78 90

417/417 S/417 WC

TAKIM KOL
DIŞ, İÇ VE WC KAPI KİLİTLERİ İÇİN
HANDLE SET
FOR EXTERIOR, INTERIOR DOOR AND WC DOOR LOCKS

Teknik Bilgiler:

> **Ayna:** Çelik. Elektrostatik boyalı. Vernikli.

> **Kollar:** Alüminyum enjeksiyon döküm. Elektrostatik boyalı. Vernikli.

Technical Information:

> **Forend Plate:** Steel. Electrostatic painted. Varnished.

> **Handles:** Aluminium alloy. Electrostatic painted. Varnished.



Kod
Code : 417 S 417 417 WC
Birim Ağırlığı
Unit Weight : 474 gr. 482 gr. 532 gr.
Koli İçi Adeti
Pieces Per Carton Box : 24 24 24
Koli Ölçüsü
Carton Box Dimension : 38X22.5X27 cm. 38X22.5X27 cm. 38X22.5X27 cm.
Koli Ağırlığı
Carton Box Weight : 11376 gr. 11568 gr. 12552 gr.

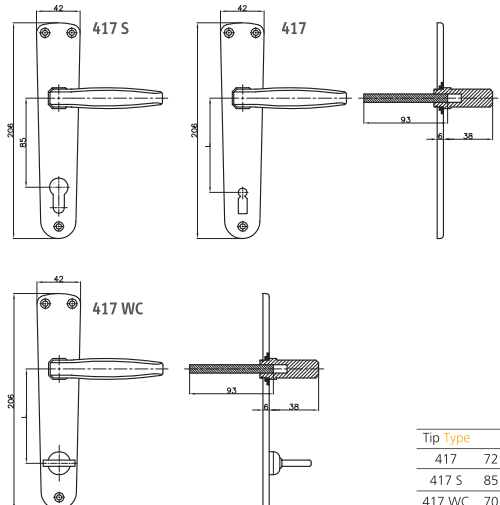

Tip Type	L
417	72 90
417 S	85
417 WC	70 72 78 90

312

TAKIM KOL
İÇ ODA KAPILARI İÇİN
HANDLE SET
FOR INTERIOR DOOR LOCKS

Teknik Bilgiler:

> Ayna: Zamak döküm. Krom kaplamalı.
> Kollar: Zamak döküm. Krom kaplamalı.

Technical Information:

> Forend Plate: Zinc alloy. Chrome plated.
> Handles: Zinc alloy. Chrome plated.



Kod Code	: 312
Birim Ağırlığı Unit Weight	: 428 gr.
Koli İçi Adeti Pieces Per Carton Box	: 30
Koli Ölçüsü Carton Box Dimension	: 37.5X21X21.5 cm.
Koli Ağırlığı Carton Box Weight	: 12840 gr.

